

SITECH[®]

Increase Productivity
with the Latest
Construction Technology



 **Trimble**
Authorized Dealer

The experienced construction professionals at SITECH® will show you how to leverage Trimble construction technology solutions, including:

- Machine Control
- Site Positioning Systems
- Construction Asset Management Services
- Construction Software

Learn how easy it is to utilize construction technology that makes significant improvements in project workflow, dramatically increases your production, improves your accuracy and lowers your operating costs through reduced survey costs, moving dirt right the first time, improved material yields, increased fuel savings and reduced operating time. With the addition of Trimble solutions to your construction projects, you're in a more powerful competitive position in the marketplace. Whether you choose to start small or go big, the expanded capability will enable you to earn the bid and be more profitable, project after project.

GLOBAL REACH + LOCAL SUPPORT

SITECH is a global distribution network for Trimble solutions - the most reliable and rugged construction technology systems available to the heavy civil construction contractor. The stability and experience of a local partner combined with the best construction technology available from Trimble. The experienced construction professionals at SITECH provide:

- Local customer service and sales
- Installation services
- Personalized training
- Technical support

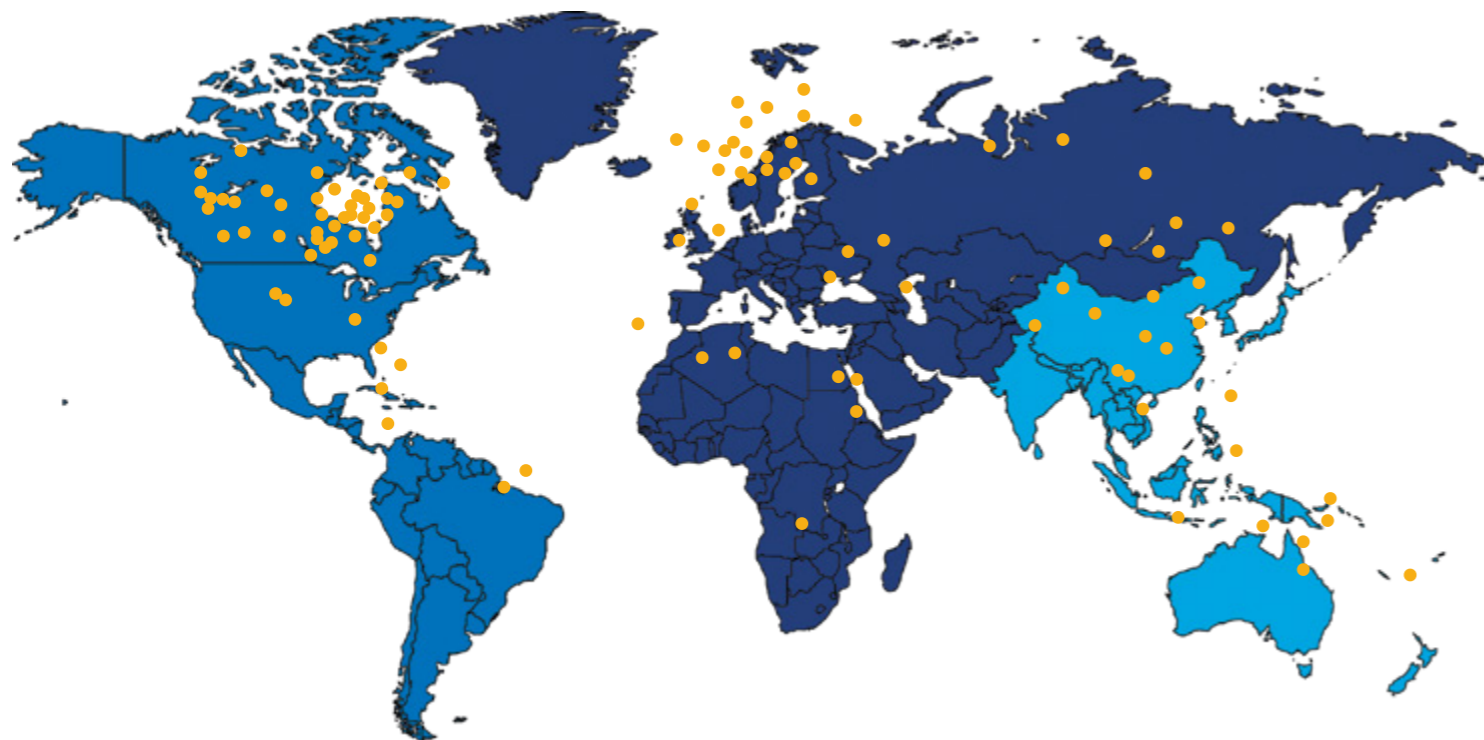

Improve efficiency and productivity, while minimizing waste and expense throughout the life of the project with Trimble® Connected Site® solutions for earthworks. Create a 3D constructible model, use it to plan the most cost-effective schedule, and then use the same model to track project progress.

SURVEY THE SITE

Collect survey, grade check, and as-built data from the field and send it to the office in real-time to build an accurate 3D constructible model for takeoff estimating, data preparation and reporting. Or take advantage of fast and safe aerial data collection with Trimble Unmanned Aircraft Systems (UAS) to replace ground surveys and provide more data at shorter intervals for lower overall cost.

With field software designed specifically for construction workflows and seamless integration with other Trimble software solutions, job site delays and rework are significantly reduced. Easy-to use and learn field software means you spend less time training and preparing data, and more time getting the job done.

BUILD A 3D CONSTRUCTIBLE MODEL

Combining current field conditions from multiple sources with design information provides the foundation for the 3D constructible model. Validate and improve the site operations plan with a 3D constructible model, so you know what to build and where to build it before costly construction begins. Adding intelligence to the model, such as how dirt will be moved, and updating the model with up-to-date field information makes the Trimble 3D constructible model a powerful tool to plan, manage and construct projects.

SYNC REAL-TIME DATA WIRELESSLY

The 3D constructible model is used to automatically sync design files and work orders between the office and the field in real-time so everyone is working with the latest files.

When up-to-date design information can be sent to the field crews or machine operators without leaving the office, you get 100% less drive time, and 100% less rework, 100% of the time.

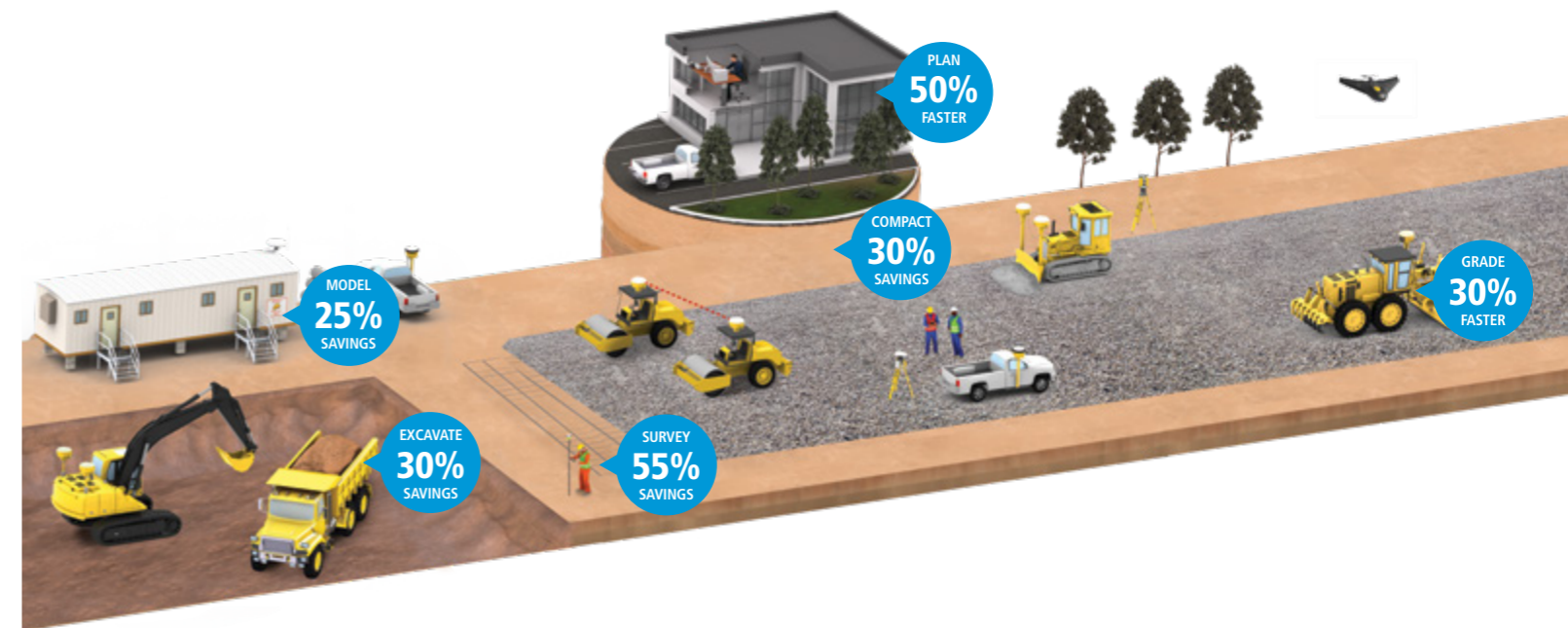

SUPPORT AND TRAIN REMOTELY

Get real-time technical support for field crew personnel or earthworks machine operators, without the time and cost of waiting for a technician to drive to the construction site. Both the field crews and the support team see the same picture, eliminating costly delays, downtime and drive time.

TRACK AND REPORT PROGRESS

Intelligently combining as-constructed information from across the project allows for advanced, near real-time reporting for progress payments. As-built progress can be monitored as the machines move dirt, and QA reporting and stakeout results can be generated.

By combining both survey and machine data, contractors get the best overall picture of the current state of the project. In addition, soil compaction operations can be monitored to ensure compaction requirements are being met.

COLLABORATE EFFECTIVELY

All your important files for the whole team are now located and backed up securely in the cloud. Overlay designs and cut/fill maps onto Google Maps or digital imagery, so everyone can see what's happening. Even site inspections and routine site visits are easily recorded and uploaded – including photos.

BENEFITS OF

MACHINE CONTROL

TRIMBLE READY

Trimble has worked with many machine manufacturers to reduce the time spent on installation of Trimble machine control. Trimble Ready[®] machines ship from the factory ready for installation of Trimble components, which can significantly reduce the cost and complexity of the installation for the contractor. By making it faster and less expensive to install Trimble technology, contractors can now realize an even quicker return on investment from their Trimble equipment. Ask your local heavy equipment dealer if the Trimble Ready option is available for your new machine.

PRODUCTION
INCREASED BY
100%

INCREASED
JOB SAFETY

98%
ON GRADE
ACCURACY

43%
SAVINGS IN
DIESEL FUEL

“ K & E has 25 – 30 pieces of equipment set-up with SITECH. We pull slopes, dig ditches . . . everything. It's a big investment, but we get it back very quickly because you have accuracy, you have productivity, you make more profit, you can get so much more done because you're running the machine at 100% efficiency. I think our return on it is a year or less. I feel Trimble equipment is top notch. We couldn't be happier – it's the only way to go.

KERRY KUENZI, PRESIDENT – K & E EXCAVATING, INC. • SALEM, OR

SITECH

PROVEN COMPONENTS

THE RIGHT FIT FOR EVERY JOB

DISPLAYS AND CONNECTIVITY

Trimble SNM941 Connected Site[®] Gateway

Connect your machine with rugged hardware from Trimble. Featuring both Wi-Fi[®] and cellular connectivity, the SNM941 enables wireless data transfer of design files and GNSS corrections, and fleet, asset and site productivity information.



Trimble CB450 and CB460 Control Boxes

Designed for use in harsh construction environments, these displays for all machine types are part of the GCS900 Grade Control System and give the operator a full-color graphical display for easy viewing and guidance to grade.

The **CB450** features include:

- 4.3" (10.9 cm) full-color LCD display with adjustable backlight controls
- Audible tones for real-time grade guidance or warnings and alerts
- Four LED light bars to provide grade guidance at a glance



The **CB460** offers the same key features as the CB450, plus:

- A large, easy-to-read 7" (17.78 cm) full-color LCD display
- Support for external light bars
- Faster data transfer via Ethernet connection



2D COMPONENTS

Spectra Precision GL700 Series Grade Laser

Spectra Precision GL722 Series Grade Lasers provide years of durable, precise machine guidance with GCS900 2D Grade Control Systems, the GCSFlex Grade Control Systems and laser-based compact machine installations. Ideal for site preparation, trenching and pipe laying, fine grading and road construction, the GL700 lasers can help you get to grade faster with more accuracy.



Trimble LR410 Laser Receiver

The LR410 is mounted to an electric mast on the blade and connected to the machine hydraulics to control lift to an accuracy of 3-6 millimeters (0.01 to 0.02 feet).



Trimble ST400 Sonic Tracer

The ST400 is mounted to the blade and uses a physical reference such as curb and gutter, stringline, existing or previous pass as an elevation reference.



Trimble TD510 and TD520 Displays

The 10-inch TD520 and 7-inch TD510 displays are the premium solution to ensure the best user experience with the Trimble Earthworks Grade Control Platform. With a specialized combination of anti-glare, powerful backlighting and advanced optical bonding techniques, these displays combine at-a-glance sunlight readability with an easy to use, multi-touch interface. Built on top of a powerful 3D graphics engine and processing platform, the Android operating system means you can extend the display with additional applications without upgrading hardware or adding an additional display.



Features include:

- Sunlight-readable, optically bonded LCD with capacitive multi-touch interaction
- Android operating system for easy software extensibility
- Powerful quad core processor platform with dedicated graphics processor
- Integrated Bluetooth and Wi-Fi for wireless connectivity
- Quick release RAM mounting for daily theft protection removal

3D COMPONENTS

Trimble MS995 GNSS Smart Antenna

The MS995 contains an integrated GPS+GNSS receiver, antenna, and isolation system all in a single, durable housing. It uses the advanced Trimble RTK engine for faster initialization times when satellite lock is lost and enhanced performance near obstructions.



Trimble GNSS MS975 Smart Antenna

The MS975 offers a cost-effective alternative for contractors who need a highly accurate GNSS receiver at a lower price point. It is optimized for cab or machine body mount only.



Trimble SNR On-Machine Radios

Rugged Trimble on-machine radios offer a modernized platform for communicating with Trimble Universal Total Stations or with a fixed GNSS base station. Available in:

- Single-band 450 MHz, 900 MHz, and 2.4 GHz
- Dual-band 900 MHz + 2.4 GHz and 450 MHz + 2.4 GHz



Trimble Total Stations

Trimble SPS Series Universal Total Stations can be used for even greater accuracy when performing fine or finished grading, with blade guidance to 2-5 millimeters (0.007 to 0.016 feet).



YOUR CONSTRUCTION TECHNOLOGY PROVIDER

TRIMBLE EARTHWORKS

CONTROL THE FUTURE

The Trimble® Earthworks Grade Control Platform for Excavators is designed to help you do more in less time. State-of-the-art software and hardware give operators of all skill levels the ability to work faster and more productively than ever before. The first aftermarket semi-automatic bucket and boom control gives your operation another competitive advantage so you can finish on-time and on-budget.

- 10" or 7" touch 3D Colour-Display
 - Gorilla® Glass
 - Best visibility even in bright sunlight
- Android® operating system
- High performance IMU sensors (10x faster)
- 2D/3D Automatic System
- With various optional upgrades



Trimble Earthworks works with **tilt automatics** on engcon®, Rototilt®, and Steelwrist® attachments. The system controls the boom and bucket of the excavator as well as the tilt angle of the attachment, while the operator controls the stick of the excavator and rotation of the tiltrotator.



2D CONFIGURATION FOR HEIGHT AND SLOPE

Flexible entry level solution for excavation, sewer construction, leveling work and profile work - the start of productivity.



3D - DUAL GNSS

Powerful 3D control system measuring the exact position of the bucket for grading and excavating tasks such as steep slopes and complex projects.



2D/3D AUTOMATIC SYSTEM

The automatic system controls the hydraulics of the machine and achieves high precision in flat or inclined surfaces. With the benefits of automatic functionality, increase the productivity of your machine up to 40%.



PAYLOAD MANAGEMENT INTEGRATION

With the addition of Trimble LOADRITE Payload Management, you can avoid overloading and underloading to be more efficient and manage costs. Featuring dynamic weighing, accurately weigh without interrupting your workflow or loading process.

INTUITIVE SOFTWARE

- Interface is optimized for ease-of-use
- Colorful graphics, natural interactions and gestures, and self-discovery features make Earthworks intuitive and easy to learn
- Each operator can personalize the interface to match their workflow using a variety of configurable views
- Files can be transferred to or from the office wirelessly and automatically so you've always got the latest design

TRIMBLE EARTHWORKS

CONTROL THE FUTURE

The proven performer for excavators has also rolled out for dozers. The Trimble Earthworks Grade Control Platform offers your dozer operators cab-mounted portability, a user-friendly Android™ UI, and the convenience of a 10-inch touch screen. Simply put, it helps new and veteran operators do things right the first time, and in less time, than ever before.



CAB-MOUNTED PORTABILITY

Trimble Earthworks for Dozers mounts dual GNSS receivers on top of the cab to eliminate masts and cables traditionally located on the blade. The dual GNSS receivers are ideal for steep slope work and complex designs with tight tolerances.

This new configuration allows you to easily remove the receivers to other machines, to maximize your investment and keep your machines working. Cab-mounting receivers is more convenient and can save you time by reducing the need to reinstall them each day.



MACHINE CONTROL REDEFINED

INTUITIVE SOFTWARE

The Trimble Earthworks software runs on the 25.7 centimeter (10-inch) Trimble TD520 or Trimble TD510 7-inch touch-screen Android displays. The software was created in collaboration with construction equipment operators around the world, so the interface is optimized for ease-of-use and productivity. Colorful graphics, natural interactions and gestures, and self-discovery features make Earthworks intuitive and easy to learn. Each operator can personalize the interface to match their workflow and a variety of configurable views make it easier to see the right perspective for maximum productivity.

Earthworks allows data files to be transferred to or from the office wirelessly and automatically so you've always got the latest design. Using the Android operating system, you can download other useful applications.

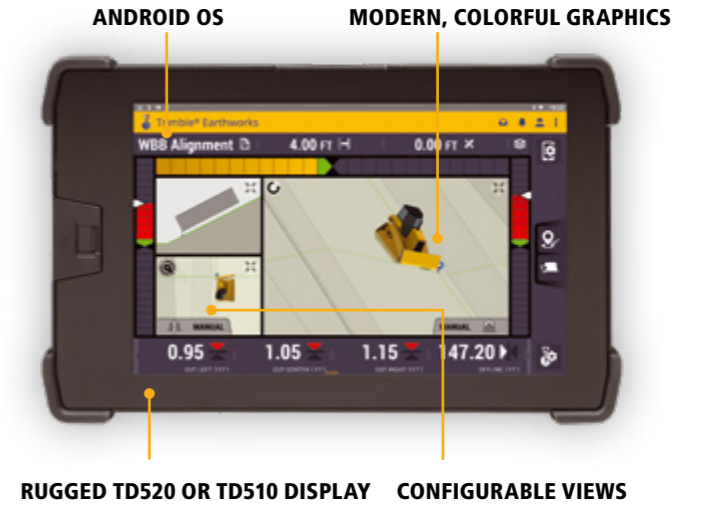

Trimble EC520 Electronic Controller

- The processing unit is separated from the display and is permanently installed on the machine
- Integrated Inertial Measurement Unit (IMU) body sensor with 6 degrees of freedom
- Optional integrated Wi-Fi for on machine wireless connectivity to Displays, Laptops, Hot Spots or Mobile devices
- 4 GB internal memory for machine data and designs



Trimble GS520 Sensor

- Six degrees of freedom inertial measurement unit, based on the latest inertial sensor technology and particularly responsive - : 100Hz, 3x axle pitch, 3x axle acceleration
- Compact form factor: Mount in any orientation
- Suitable for harsh vibration environments (excavator bucket and dozer blades)
- Mount directly to linkage; no shock mounting required
- Precision locating feature for positioning and re-positioning



TRIMBLE EARTHWORKS

CONTROL THE FUTURE

The Trimble® Earthworks Grade Control Platform for motor graders helps operators of all levels leave a quality surface. This next generation system with a familiar Android™ UI, and user friendly 10-inch touch screen cuts the learning curve, improves operator capabilities, and gives you a first-pass finish that's second to none.

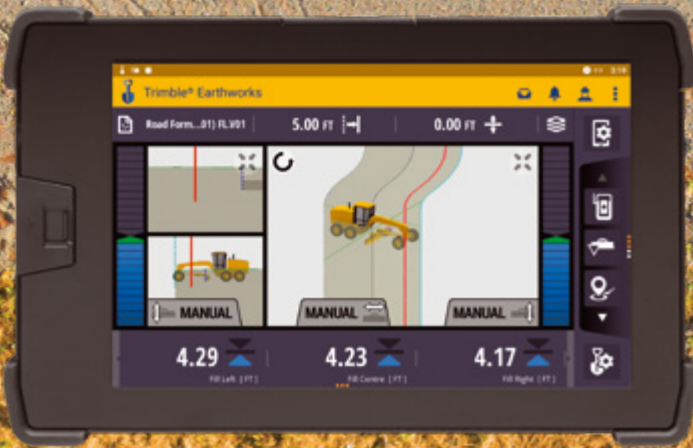

MACHINE CONTROL REDEFINED

DUAL-GNSS ACCURACY

Trimble, a leader in precision measurement technology, pioneered the dual GNSS solution to meet the needs of the construction industry. Dual GNSS provides real-time position and heading of the machine for guidance of the motor grader blade in 3D, enabling faster reaction times and enhanced performance.

The IMU-based system offers even better GNSS performance, for more accuracy and stability. The platform supports multiple correction services, including VRS and Internet Base Station Service (IBSS). And when a correction source is temporarily unavailable, the Trimble xFill feature will fill in the gaps to maximize up-time.

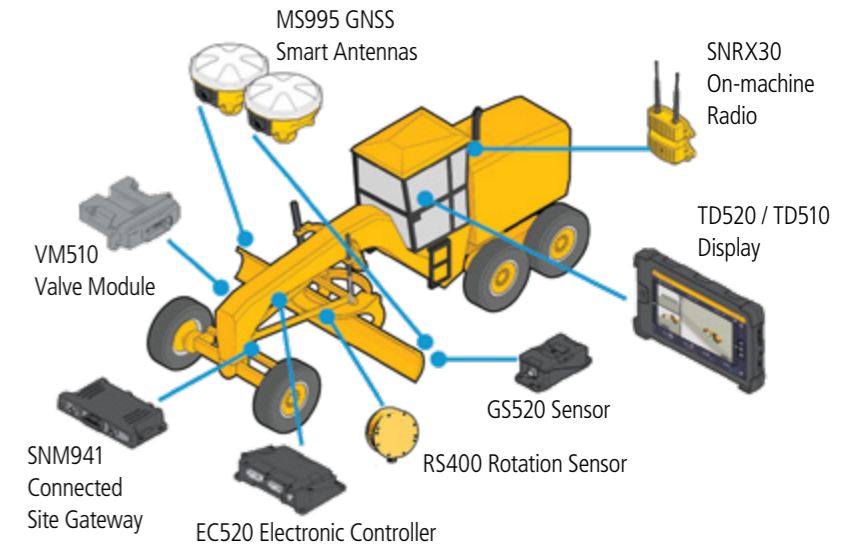

LEGENDARY PRECISION WITH UTS

Earthworks for Motor Graders with Trimble Universal Total Stations is THE configuration for finish grading with fewer passes. Contractors can place finished grade materials more accurately and in a shorter time period, keeping material costs to a minimum and improving productivity.



SPS930 Total Station

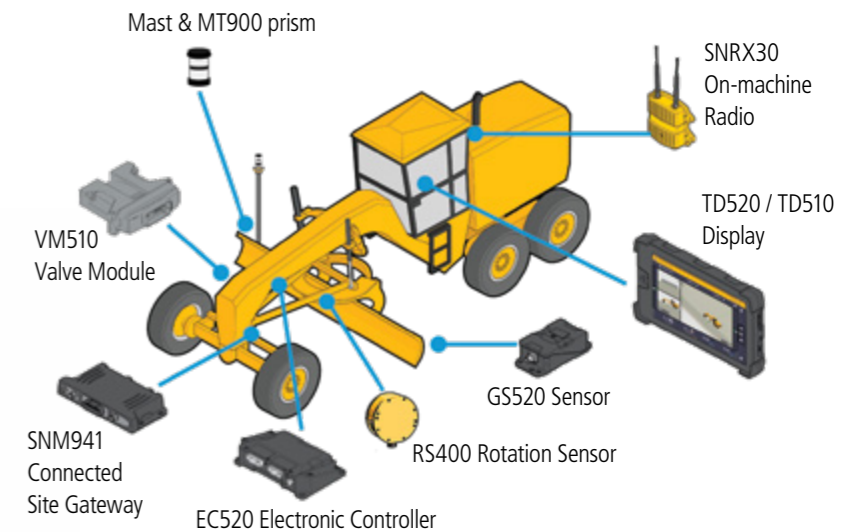

TRIMBLE EARTHWORKS GO!

2D GRADE CONTROL SYSTEM FOR COMPACT GRADING ATTACHMENTS



Trimble Earthworks GO! can be used by contractors involved in general construction, site preparation and utility work for grading flat and simple slopes. The system leverages laser technology to provide dynamic, real-time position information that allows the operator to grade or cut profiles quickly and accurately.

The platform requires little training time and can increase an operator's productivity up to 20 percent. At the core of the system is the Earthworks GO! software that guides the user through installation, setup and operating modes. The software was specifically designed for local small site contractors and owner-operators, featuring unparalleled ease-of-use. iOS and Android compatibility allows operators to use their smartphone as the primary machine interface.

Trimble Earthworks GO! is the easiest system on the market to install. Trimble's proprietary GO! Box enables full sensing technology with no mounting hardware needed. Contractors can save machine profiles to the GO! Box to ensure the grading attachment only needs to be set up once. This innovative capability makes it quick and easy to move the system between machines.

EASY TO USE, PORTABLE PLATFORM

UNPARALLELED PORTABILITY

Earthworks GO! proprietary Trimble GO! Box technology lets contractors quickly swap the system between machines to take care of the job at hand. Save machine profiles to the GO! Box to ensure you only have to set up your machines once, so you can get back to work.

Ultra-portable and intuitive, Earthworks GO! provides high accuracy performance in all common grading applications such as pads, parking lots, sports fields, landscaping and more. It also works across the entire fleet of attachments for compact track and skid steer loaders.

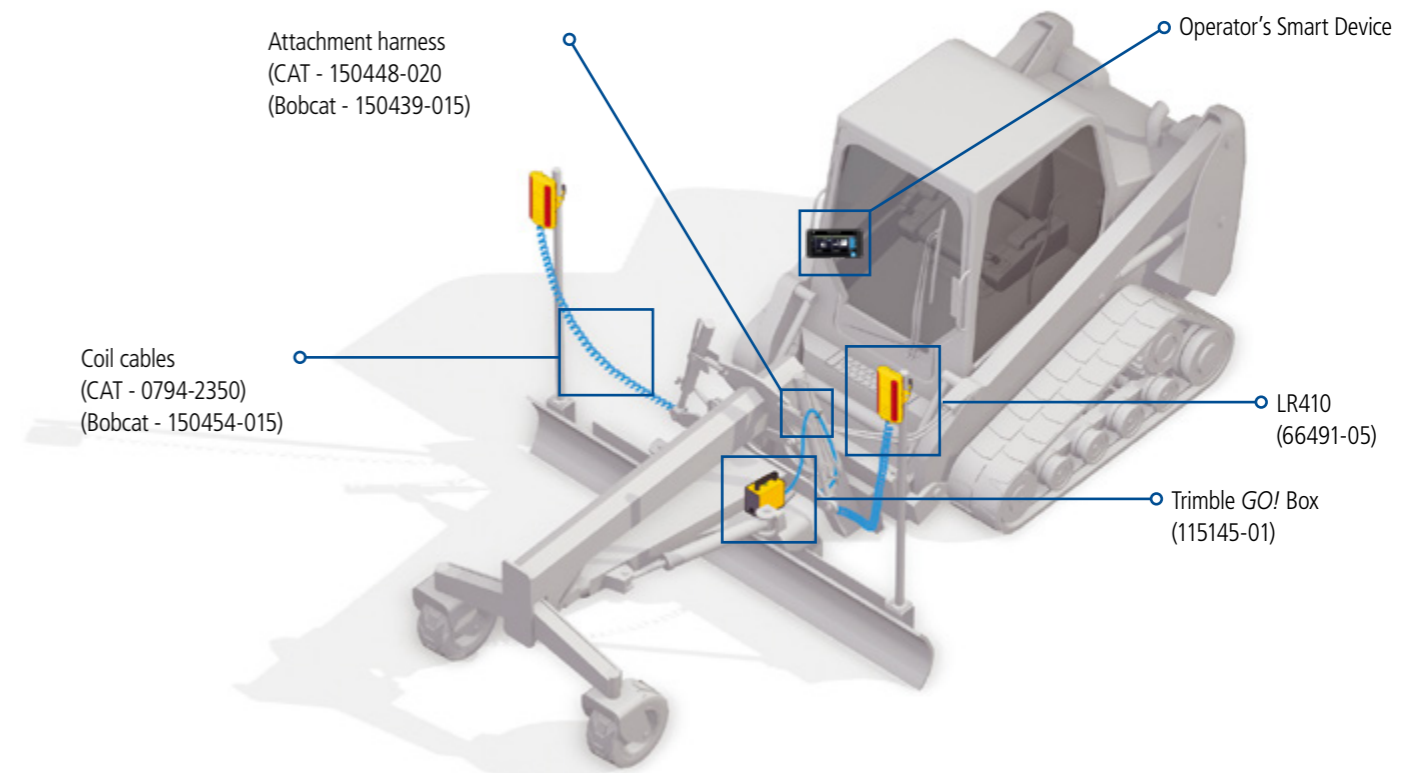
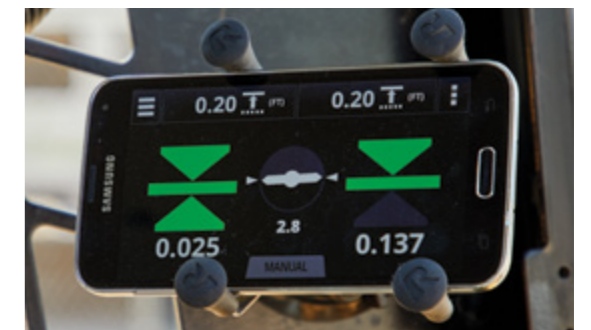

Trimble machine control systems are flexible enough to let you equip your entire fleet—excavators, dozers, scrapers, graders, trimmers, milling machines, compactors, pavers and more—with fully upgradeable technology. Start where you need to start and add as you need to add. Select the best option for the machine and application: sonic, angle sensors, laser, GNSS, total station.

2D ENTRY-LEVEL MACHINE CONTROL SYSTEMS

Trimble entry-level 2D machine control systems are ideal for smaller projects from initial site prep through to finished grading and paving, and leverage a range of fully portable components. All components are easy to move from machine-to-machine, easy to use, quick to set up and extremely durable to ensure the highest uptime and longest life possible in jobsite conditions. Additionally, these systems can be operated in manual or auto mode; in auto mode the blade is automatically moved to the correct position.

2D MACHINE CONTROL SYSTEMS

CONFIGURATION	TARGET MACHINES	DESCRIPTION	KEY COMPONENTS
CROSS-SLOPE ONLY	Dozers, Graders, Compact Grading Attachments	Cross-slope control system to be used on motor graders for fine grading work for road maintenance, ditches and slope work	2 angle sensors, Rotation sensor Control box, SNM941
SINGLE ELEVATION PLUS CROSS-SLOPE	Dozers, Graders, Compact Grading Attachments	Single control system uses a laser or sonic receiver to control the lift of the machine blade and the cross-slope for flat, slope work, and finished grading	Laser, Laser receiver -or- Sonic tracer, Rotation sensor, 2 angle sensors, Control box, SNM941
DUAL ELEVATION	Dozers, Graders, Compact Grading Attachments	Dual control system that uses two laser or sonic receivers for higher accuracy lift control, blade edge can be controlled independently or linked	Laser, 2 Laser receivers -or- 2 Sonic Tracers, Control box SNM941
DEPTH, SLOPE, AND ELEVATION CONTROL	Excavators	Highly flexible system for excavation, trenching, grading and profile work	Angle sensors, Laser catcher, Control box, SNM941

3D MACHINE CONTROL SYSTEMS

Trimble machine control systems are the most versatile grading technologies available and can be used on a wide range of machine types including excavators, dozers, motor graders, compactors, milling machines, trimmers, pavers and more. By putting design surfaces, grades and alignments inside the cab, the system gives operators unprecedented control over grading, excavating, compaction and paving applications, significantly reducing material overages and dramatically improving productivity and profitability. The 3D systems can be operated in manual or auto mode and leverage a range of components that are fully portable and can be easily moved from machine to machine.

3D MACHINE CONTROL SYSTEMS

CONFIGURATION	TARGET MACHINES	DESCRIPTION	KEY COMPONENTS
SINGLE GNSS	Dozers, Graders, Scrapers, Excavators, Compact Grading Attachments	Measures the position and slope of the blade and compares that to design data for grading and mass excavation on complex design surfaces	Angle and rotation sensors, Single GNSS Smart Antenna, Control box, Rugged on-machine radio and SNM941
DUAL GNSS	Dozers, Graders, Scrapers, Excavators, Compact Grading Attachments	Measures the exact position, cross slope and heading of the blade, bucket, drum for rough grading and mass excavation on steep slopes and complex design surfaces	Dual GNSS Smart Antennas, Control box, Rugged on-machine radio and SNM941
CAB-MOUNTED SINGLE GNSS	Dozers, Wheel Loaders	Measures the position of the blade on the ground, comparing that to the 3D design for rough grading applications	Single GNSS Smart Antenna, Control box, Rugged on-machine radio and SNM941
SINGLE OR DUAL GNSS WITH LASER AUGMENTATION	Dozers, Graders	Single and dual GNSS systems enhanced with laser augmentation to improve vertical accuracy for high accuracy grading to complex design surfaces such as super-elevation grading for rough through finished grade work	Single or dual GNSS Smart Antenna(s), Laser receiver, Control box, Rugged on-machine radio and SNM941
UNIVERSAL TOTAL STATION	Dozers, Graders, Excavators, Soil Compactors, Compact Grading Attachments	Total station-based system for high accuracy lift and layer control, material placement and monitoring, or for jobs where GNSS is not the ideal solution because of overhead obstructions	Single on-machine active target, Control box, Universal Total Station, Rugged on-machine radio and SNM941
3D + SONIC	Graders, Compact Grading Attachments	Uses 3D control on one blade tip and a sonic tracer on the other blade tip to match an existing structure, feature or the last machine pass	On-machine active target -or- GNSS Smart Antenna(s), Sonic tracer, Control box, Rugged on-machine radio and SNM941



Reliability is critical in paving work because the paving can not stop. Trimble components are built to withstand the heat, steam, tamping and vibration that are regular on pavers, milling machines and compactors. And while system durability prevents downtime, Trimble's extensive dealer network ensures that training and support is always close.

PAVING COMPONENTS TO STAND UP TO ANY JOB CONDITION



CB440 Control Box

- Monitor both sides of the screed with one operator with split-screen feature
- Bright dual light bars per box can be monitored from a distance
- Easy operation: start a paving run with only 2 button clicks
- Easy operator control of height and slope settings
- Single or dual-operator control



AS200 Angle Sensor

- One of the most accurate slope sensors in the business
- Produces slopes as tight as 0.5%



CS200 Contact Sensor

- Mechanically traces a surface or a stringline



ST200 Sonic Tracer

- The five sensors on the sonic tracer average out small irregularities on the surface
- Contact-free sensing of ground, curb or stringline
- More than 25 centimeters (10 inches) of sensing range when placed perpendicular to a stringline or narrow curb
- Maintenance-free ceramic sensors
- Automatic temperature compensation

TRIMBLE BUSINESS CENTER SOFTWARE GOOD DESIGNS MAKE GOOD SURFACES.

Data preparation and management is easy with Trimble Business Center.

Using Trimble Business Center, you can create 3D design models and automatically generate uncompacted surface designs for the Trimble PCS900 3D paving system.

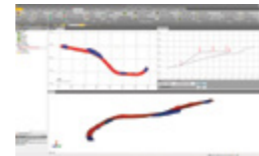

The uncompacted surface designs guide the paver to automatically lay more material above low areas and less material in high areas, anticipating and eliminating longitudinal waves that can occur after asphalt compaction.

TRIMBLE SPS930 UNIVERSAL TOTAL STATION

The Trimble SPS930 Universal Total Station controls alignment of the machine and gives the system millimeter control over the pan. It works flawlessly in tunnels and overpasses, in tight corridors and over long distances. It also:

- Offers the best accuracy on the market— every millimeter saved reduces your milling and paving costs substantially
- It can very accurately drive the mill drum to cut to the 3D design within 3-6 millimeters (0.01 - 0.02 feet).
- Is flexible and reliable—you can work on sites where there is an obstructed view of the sky
- Has a 45 degree tracking angle—you can set it up very close to the mill in narrow corridors or in the drainage area between divided highways
- Transitions faster—Trimble Hot Swap technology transitions to the next total station without stopping the machine
- Maximizes your return on investment— other survey and machine control work can be done with the same instrument

TRIMBLE HOT SWAP

Trimble Hot Swap technology makes total station transitions faster and less dependent on manual intervention from the operator. It automatically maintains the same tolerance between total stations, ensuring a smoother surface at the transition point and reducing the need to grind problem spots.

3D MILLING WITH TRIMBLE PCS900 PAVING CONTROL SYSTEM

Milling to a fixed depth often satisfies the specification for a resurfacing project, but it leaves any road smoothness improvements to the paver. With the Trimble PCS900 Paving Control System you can mill at variable depth and slope, eliminating undulations and preparing a smoother sub-surface for new asphalt. When used in conjunction with a paver equipped with PCS400 or PCS900, the end result is a significantly smoother road surface using less material and finished in less time.

ACCURATE MILLING, NO STRINGLINES

Accurate milling begins with a quality 3D design model created in Trimble Business Center. The 3D design is displayed to the machine operator showing areas that are on, above, or below ideal grade. Comparing the actual drum position and slope with the digital design, the system automatically guides the milling drum to cut the ideal depth and slope without stringlines or manual adjustments.

With PCS900 on your mill, you easily handle transitions, super-elevated curves, variable drainage slopes and longitudinal waves. And you can do it all without re-work.

MILL SMARTER

Using PCS900 on your milling machine provides several benefits:

- Smoother base—mill out the existing undulations, creating a smoother surface for paving
- Shorter lane shutdowns—trucks can run more efficiently unhindered by stringline and stakes
- Reduced machine wear—by only milling to the depth required, the machine will burn less fuel and experience less teeth wear
- Less material to remove—fewer trucks and cost required to remove waste material
- Less asphalt usage—mill off the minimum depth and use less asphalt for the final surface



PRISM:

Patented Trimble active tracking technology guarantees total station lock to the on-machine target and ensures millimeter control of the milling machine drum.

TRIMBLE CB460 CONTROL BOX:

The Trimble CB460 Control Box indicates the position of the drum versus the 3D design or pre-defined vertical offset.



TRIMBLE ROADING SOLUTIONS

2D PAVING

2D PAVING WITH TRIMBLE PCS400 PAVING CONTROL SYSTEM

The Trimble PCS400 Paving Control System is ideal for projects that require meeting a thickness specification. When milling is done to design using Trimble 3D technology, Trimble 2D paving technology can easily handle the task of paving a fixed thickness.

The Trimble PCS400 Paving Control System can reference off a surface, stringline or cross-slope. This makes the PCS400 an excellent, lower cost option for roads that have been graded or milled using Trimble PCS900 Paving Control Systems.

MANY BENEFITS FROM ONE SYSTEM

The Trimble PCS400 system can help you:

- Lay the finished surface with accuracy to 3 millimeters (0.01 feet)
- Minimize use of expensive material, pave within a tighter tolerance and get closer to the minimal asphalt thickness specification
- Reduce labor costs by controlling the screed with one operator
- Eliminate operator mistakes with the easy-to-use display interface
- Achieve maximum smoothness and rideability
- Finish on time

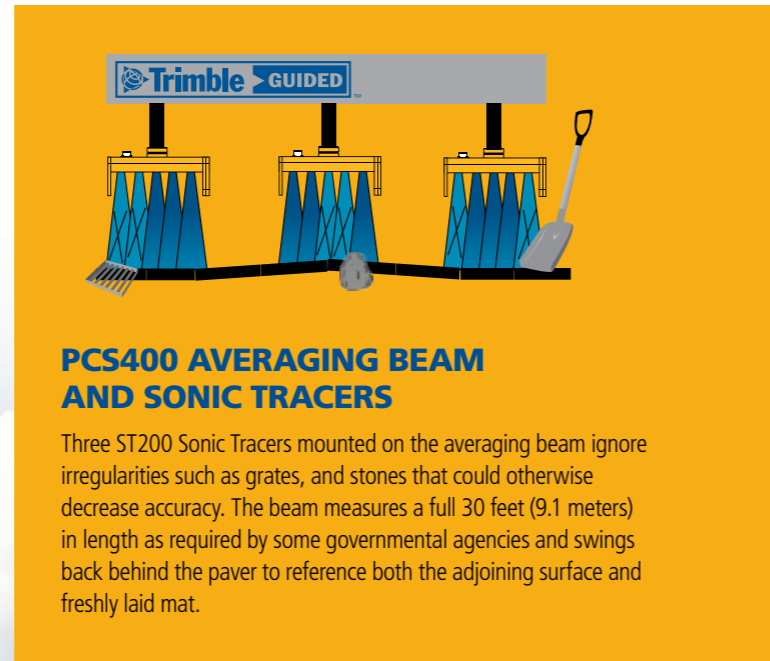

PCS400 AVERAGING BEAM AND SONIC TRACERS

Three ST200 Sonic Tracers mounted on the averaging beam ignore irregularities such as grates, and stones that could otherwise decrease accuracy. The beam measures a full 30 feet (9.1 meters) in length as required by some governmental agencies and swings back behind the paver to reference both the adjoining surface and freshly laid mat.



TRIMBLE CB440 CONTROL BOX:

The Trimble CB440 Control Box displays the measured and target values of the cross slope and mat thickness simultaneously.

TRIMBLE ST200 SONIC TRACER:

The PCS400 Averaging Beam uses three evenly spaced Trimble ST200 Sonic Tracers to average out uneven reference surfaces.

TRIMBLE ROADING SOLUTIONS

3D ASPHALT PAVING

3D PAVING WITH TRIMBLE PCS900

The Trimble PCS900 Paving Control System adds the accuracy and flexibility of 3D technology and allows you to also pave with variable depth and slope based on the 3D design.

AVOID THE PROBLEMS OF STRINGLINE

3D technology resolves the problems inherent to stringline because:

- It eliminates time consuming and costly manual setup and possible human errors
- It eliminates the possibility that stringlines can be moved or damaged
- It improves truck productivity with less travelling and maneuvering around the stringlines

PRECISION PAVING WITH LESS MATERIAL

The PCS900 system regularly achieves asphalt mat accuracies of 3-6 millimeters (0.01-0.02 feet), making it ideal for projects such as airports, large commercial surfaces and highways.

Accurate 3D control of the screed allows you to:

- Take out high and low areas early in the process with the less expensive materials
- Increase road smoothness using less asphalt than with traditional paving methods
- Lay complex designs such as transitions, super-elevated curves and frequently changing cross slopes
- Achieve accuracy and smoothness specifications, which can mean bonus income

TRIMBLE CB460 CONTROL BOX

The Trimble CB460 Control Box offers an 18 centimeter (7 inch) graphical display and adjustable light settings for day or night paving.

PRISM

Patented Trimble active tracking technology guarantees total station lock to the on-machine target and millimeter control of the screed.



HOT SWAP TRANSITIONS:

Unique Trimble technology allows the system to hot swap, or instantly transition, to the next total station without stopping the machine to make adjustments.

TRIMBLE CB440 CONTROL BOX:

The Trimble CB440 Control Box displays the measured and target values of the cross slope and mat thickness simultaneously.

TRIMBLE ROADING SOLUTIONS

3D SLIPFORM PAVING

NO STRING, NO DELAYS

It's time to kick stringline off your job site...for good.

Stringline delays your pour, it costs too much, and it's just too hard for your haul trucks to drive around. Every time it breaks, you have to stop the machine. Every time it sags, your surface suffers and so does your bonus.

Once you start paving with the Trimble PCS900 Paving Control System, you'll wonder how you could ever use string in the first place. You'll start working faster every day. Your haul trucks can pull up and dump without driving around string. You'll stop less often, grind fewer problem spots and blow away your target IRI number.

MORE CONTROL, LESS WASTE

Trimble PCS900 Paving Control System for Slipform Pavers uses automatic steering and 6-way control of the pan to keep the paver exactly on the target alignment, grade and slope. The result is a more consistent concrete surface with better rideability and a bigger bonus – without the time and cost of string.

You'll see efficiency improvements through:

- Improved site logistics and safety
- On time delivery of mix
- Better yield
- Increased smoothness

ONE INTEGRATED WORKFLOW

The cost of concrete rework is too high to be working with multiple manufacturers and file formats. Using one integrated workflow from Trimble, you can be confident of the quality of your work, and stake your reputation on the results.

Pave to the 3D design, and your grade checker can work from the screed using a Trimble rover, the same 3D design model and total stations to verify the as-poured surface.

Plus, training and support from your local SITECH® Technology Dealer means you are never working alone.

TRIMBLE ROADING SOLUTIONS

ASPHALT AND SOIL COMPACTION

3D COMPACTION WITH TRIMBLE CCS900

The asphalt compactor is the last machine to pass over your paving project, and mistakes during this phase can be very costly to fix. You can significantly reduce the need for re-work by installing the Trimble CCS900 Compaction Control System on your asphalt compactors.

The CCS900 system eliminates much of the guess work from asphalt compaction and helps achieve more consistent compaction to target design density. You will also be able to roll a more efficient pattern, increase productivity, and save fuel.

MAP IT AND GET IT RIGHT

Pass count mapping in the CCS900 system allows you to monitor the number of passes over an area and adjust your effort to avoid over or under-compaction. Using the roof-mounted GNSS receiver or machine target, the system calculates the exact position of the machine and displays a color map indicating the current number of passes and where you have overlaps or gaps. When installed with two optional IS310 Infrared Sensors, CCS900 maps the surface temperature of the mat and pinpoints exactly where you need to be for ideal compaction timing.

REPORTING AND DOCUMENTATION

In-field reporting and an in-cab printer allow on-site supervisors and quality managers to monitor compaction operations and correct possible issues immediately. Compaction data logs can be wirelessly transferred from the machine to the office for analysis using the web-based VisionLink fleet, asset and productivity management solution from Trimble.

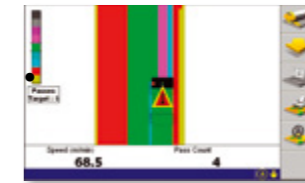

Operator view of pass count mapping

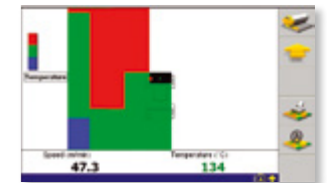

Operator view of temperature mapping

MONITORING COMPACTION IN VISIONLINK

For longer term analysis of compaction operations and productivity enhancements, VisionLink 3D Productivity Manager lets you:

- Continuously monitor pass counts and compaction meter values to improve testing success, reduce rework and lower ongoing maintenance costs
- Reduce over-compaction to optimize fuel use and machine time
- Monitor temperature maps to ensure compaction per the target temperature range



MS972 GNSS SMART ANTENNA

The Trimble MS972 Smart GNSS Antenna measures the position of the compactor using a base station or satellite delivered correction sources such as SBAS.

IS310 INFRARED TEMPERATURE SENSORS

IS310 Infrared Temperature Sensors measure surface temperature of the mat in the direction of operation.

CB460 OR CB450 CONTROL BOX

The Control Box graphically maps pass counts and surface temperature readings with high and low temperature warnings to indicate potential issues in real-time.



TRIMBLE GROUNDWORKS

MACHINE CONTROL SYSTEM FOR DRILLING AND PILING



Trimble Groundworks can enhance worksite safety, accuracy and the efficiency of your drilling and piling operations. All day, every day, in any weather.

Realize maximum production and revenue with the Trimble® Groundworks Machine Control System—an aftermarket, land-based, 3D drilling and piling system for the mixed fleet operator.

- Stakeless drilling or piling and minimal lay out reduces workload and cost
- Keep personnel safe by reducing the need to be near machines and warns the operator when entering avoidance zones
- Limit operator fatigue by reducing paperwork

Trimble Groundworks pays for itself by:

- Using RTK for extreme precision and accuracy
- Piling and drilling exactly to defined elevation using Auto Stop
- Navigating to battered or vertical piles or holes from any direction
- Reducing time and money spent on surveyors and stakes
- Logging as-built data during operation
- Reducing rework
- Reducing site visits by syncing data via Wi-Fi or cellular direct to the office

OPTIMIZE DRILLING AND PILING

PRODUCTION AND REVENUE

TRIMBLE VERSO 12 DISPLAY

Keep your machines working. Not waiting.

Your machines can be up and running 24/7 with the rugged and fully connected Trimble VERSO 12 and Trimble Groundworks Software. The easy-to-read touch screen makes navigation simple and quick.

- Rugged VERSO 12 display
- Clearly see avoidance zones for safer worksites
- Configurable views
- Easy to use, intuitive interface
- Modern colorful graphics

Part of the Trimble Connected Site® portfolio, Trimble Groundworks is an integrated solution that brings the office and the field together to give you less rework, more productivity, and best of all — more profitability.

- Trimble Business Center creates and manages design data to avoid costly mistakes
- Connected Community allows design data to be shared in the cloud and ensures operators are always working with the most recent information
- Trimble Groundworks gathers as built data so Trimble Business Center can run accurate quality, production, and utilization reports



TRIMBLE BUSINESS CENTER

Optimized drill plans. Optimal results.

Rapidly create optimized 3D drill or pile plans with Trimble Business Center, then generate comprehensive quality and production reports. With Trimble Business Center and Trimble Groundworks, more profits are at your fingertips.

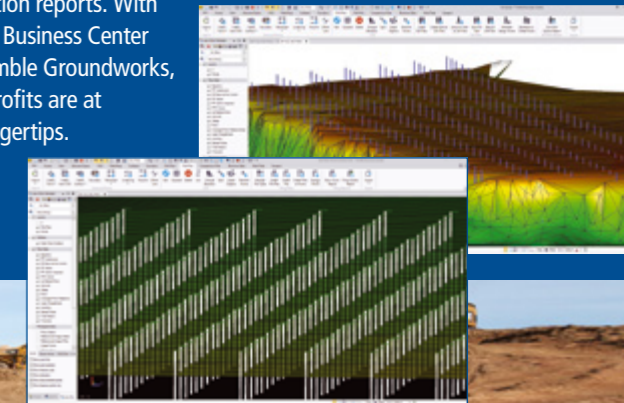

TRIMBLE BUSINESS CENTER

POWERFUL TOOL TO MANAGE DATA AND CREATE DESIGNS

Trimble Business Center contains powerful tools to help you quickly and easily create accurate, integrated 3D constructible models for sites, highways and marine applications. Make better decisions, decrease costly mistakes, and increase efficiency in the office and on the job site.

- Reduce drive time by effectively and seamlessly managing data between the office, Trimble Site Positioning Systems and Trimble machine control technology
- Rapidly create, edit and draft, generate reports and plots, and publish information
- Reduce rework by ensuring data is clean, up-to-date and delivered in the right format to get the job done
- Win more bids by preparing earthwork and construction takeoffs quickly and accurately with expanded levels of detail
- Increase profit by optimizing the site and corridor earthworks
- Works seamlessly with Trimble Siteworks Software, SCS900 Site Controller Software, Trimble Earthworks, Trimble GCS900 Grade Control System, Trimble PCS900 Paving Control System, Trimble CCS900 Compaction Control System, Cat® AccuGrade™ and Cat GRADE Grade Control Systems



EDITIONS AND MODULES

Trimble Business Center is available in editions, with add-on modules to customize functionality for your specific workflow.

Viewer Edition

- Basic functionality available at no cost
- Import and export data to Trimble field devices
- Data viewing and querying of properties

Field Data Edition

- Fast, accurate and affordable field data management
- Add the GIS Module to view Geographic Information System (GIS) data
- Basic CAD drawing and editing functions
- Level and Total Station data processing

Surface Modeling Edition

- Create, edit and manage surface models
- Compute and report volumes and areas
- Create cut fill maps
- Create, edit, label and manage alignments
- Add the Drilling, Piling and Dynamic Compaction Module to access features for specialized groundwork applications

Survey Intermediate Edition

- Import, georeference, edit and extract vectors from Adobe® PDF and image files
- Calculate network adjustments
- Carry out site calibration computations
- Create dynamic labels and tables

Survey Advanced Edition

- Create and run TML macros (Python-based scripts)
- Create and edit corridor models and surfaces
- Advanced drafting features bring polished design to your presentation, work plans or as-built information
- Includes advanced survey features
- For advanced functionality, add the Mobile Mapping Module
- Add the Tunneling Module to more effectively manage tunneling project data
- Add the Scanning Module and Aerial Photogrammetry Module for additional surveying functionality

Site Modeling Edition

- Data prep functionality quickly converts 2D or improperly elevated CAD data into properly elevated objects that can be sent to the field for construction
- Includes site modeling tools and an interface to VisionLink production models
- Add the Utility Modeling Module to simplify site and infrastructure construction

Site Construction Edition

- Site takeoff features save time and decrease the learning curve by using one piece of software to import Adobe PDFs, trace contour lines, create surfaces, apply site improvements to specify materials and depths and get an accurate report of quantities and costs
- Streamline your entire workflow from estimation, to design through preparation and drafting
- Create and edit site mass haul computations to balance earthwork and minimize earth moving
- With added road takeoff tools, convert digital CAD cross-sections, rapidly extract cross-section information from Adobe PDF vector files and quickly see locations and quantities of materials

Infrastructure Edition

- Linear mass haul functionality helps determine how much to move, from where, to where, and what it will cost to get it all done
- Included intersection design workflow reduces the complex and labor-intensive design task to minutes by automatically creating parametric intersections from corridors with defined templates

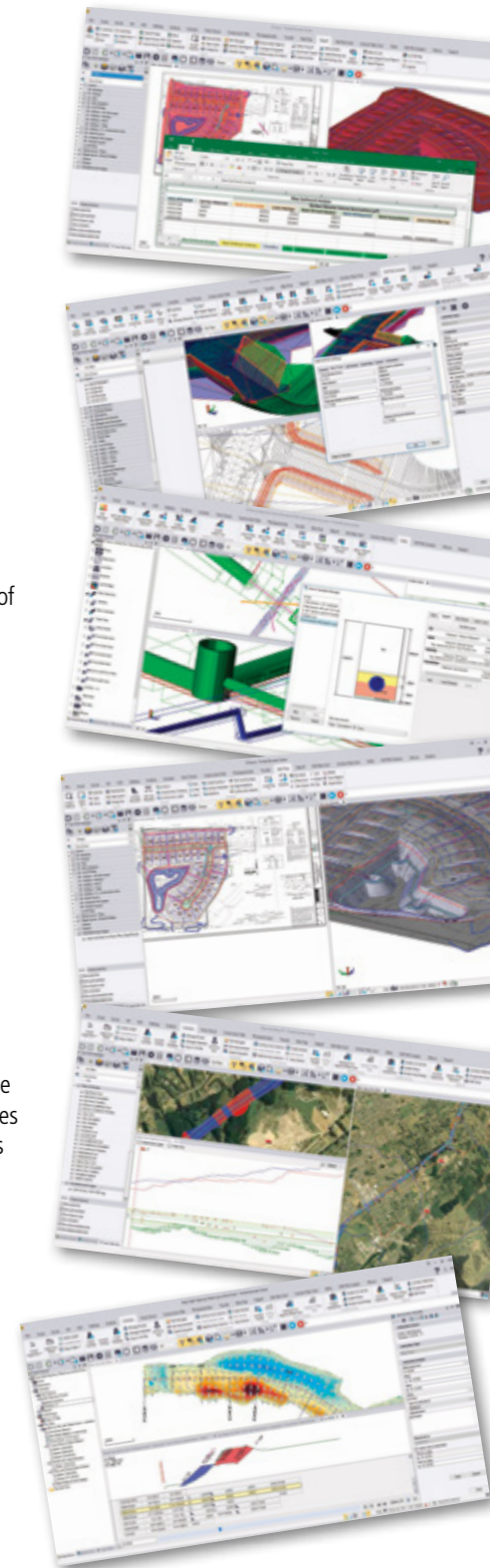

VISIONLINK UNIFIED SUITE

HEALTH, LOCATION AND PRODUCTIVITY INFORMATION

VisionLink® offers a unified view of health, location and productivity for your fleet, regardless of manufacturer, providing actionable information for key decision-making to help you improve your bottom line. VisionLink Unified Suite mobile-ready applications include Unified Fleet, Unified Service, Unified Productivity and Administrator.



VISIONLINK UNIFIED FLEET

VisionLink Unified Fleet's user-friendly screens display asset information to help better manage a mixed fleet, no matter the machine brand. Developed with the fleet or equipment manager and owner/operator in mind, VisionLink Unified Fleet's user-friendly and configurable dashboard displays information such as: hours, miles, fuel, odometer, locations, idle time, asset status, asset utilization and operation, and customer-defined asset states.



VISIONLINK UNIFIED SERVICE

VisionLink Unified Service integrates health and maintenance information, delivering a complete picture of fleet health that allows users to proactively schedule maintenance while minimizing asset downtime. To stay operational and extend asset life, manage maintenance schedules and track machine health with VisionLink Unified Service.

VISIONLINK ADMINISTRATOR

VisionLink Administrator unifies all of the applications by enabling users to define what is important, manage access and configure settings to optimize workflow. Designed to provide administrative functions across the VisionLink Unified Suite of applications, VisionLink Administrator allows user-assigned administrators to set up and manage users, geofences, asset settings, reports, notifications, workflows and more from a centralized location.



VISIONLINK UNIFIED PRODUCTIVITY

VisionLink Unified Productivity optimizes project productivity by monitoring the movement of materials against project or asset targets, helping project managers, foremen and operators maximize site efficiency in near real-time to keep projects on time and on budget. This application enables monitoring of payload, volumes, as well as other material movement metrics including load counts and cycle times.



VISIONLINK 3D PRODUCTIVITY MANAGER

VisionLink 3D Productivity Manager provides a complete view of cut/fill, volume, and compaction data so you can leverage all of your jobsite data from machines, to surveys and drones for improved decision making. VisionLink provides actionable information for key decision-making to help improve your bottom line on any device at any time.

Boost your ROI from machine control investments by leveraging the power of VisionLink and combine survey and design data with machine data all in one software.

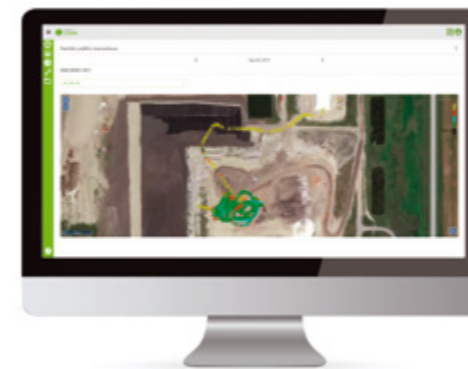

VISIONLINK LANDFILL

The VisionLink Landfill application is designed to help you better manage your solid waste landfill. Developed with the Landfill Manager in mind, VisionLink Landfill tracks the compaction and fill processes at your site when coupled with landfill compactors that have Trimble CCS900 Compaction Control Systems or Cat AccuGrade Compaction Control Systems from Caterpillar or Trimble.

VisionLink Landfill can track the compaction efforts of these GPS-equipped compactors and can calculate the waste volumes placed and the compaction densities achieved in your active cells. Get better compaction and maximize the life of your landfill with VisionLink Landfill.

TRIMBLE STRATUS

DRONE DATA PLATFORM FOR CONSTRUCTION

DRONE DATA ANALYTICS

Trimble Stratus software helps civil contractors use drones to map, measure and share accurate information about their worksites and assets. With Stratus, you can make quicker decisions, avoid mistakes, and grow profits by always having the right information on hand.

CONFIDENTLY PLAN AND ESTIMATE

Know what you're quoting: Conduct your own site surveys before the job begins, and whenever changes occur.

SURVEY FREQUENTLY AND FASTER

Get accurate, up-to-date topographic surveys whenever you need.

COMMUNICATE EFFECTIVELY

A visual timeline keeps everyone on the same page. Track site changes, avoid crossed wires, and resolve disputes quickly.

TAKE CONTROL

Save money and avoid information bottlenecks. Get answers to questions yourself with an intuitive, web-based tool.

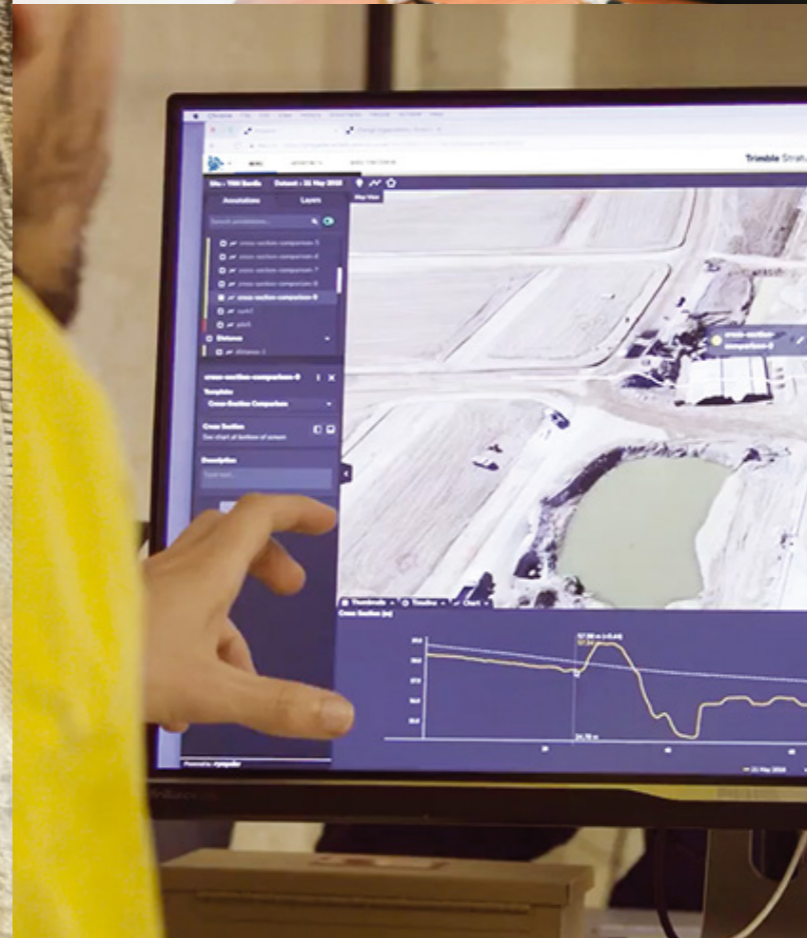
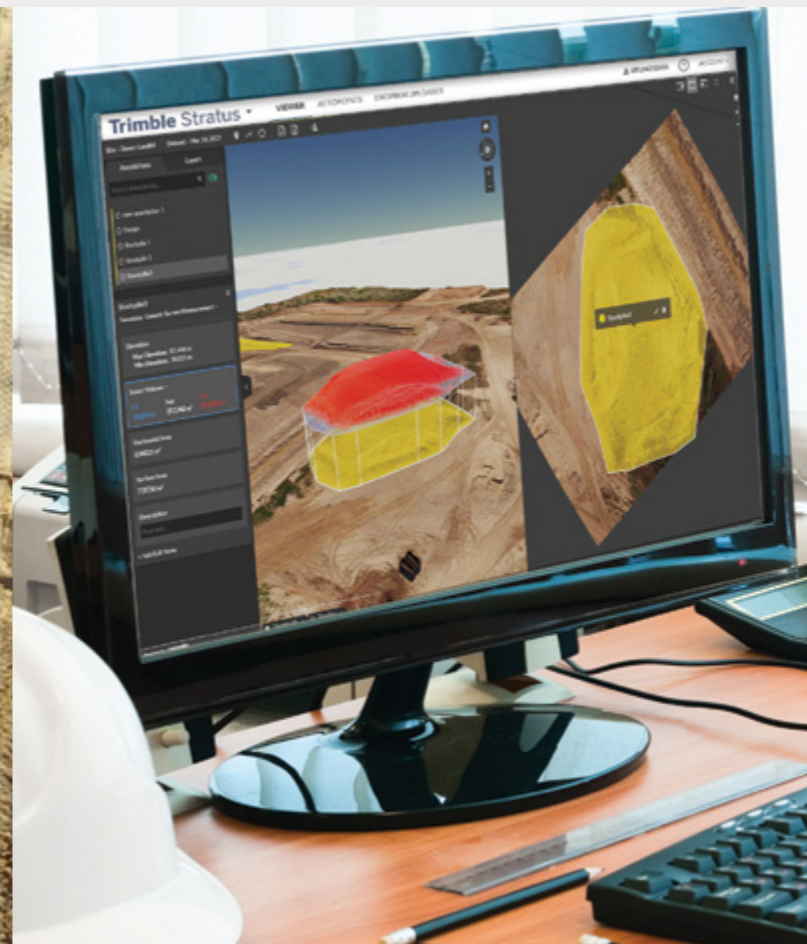

SITE VOLUMES

- Calculate overall material volumes added or removed from pits, stockpiles, cells, drainage channels, etc.

DESIGN CHECKS

- Upload design file to compare actual surface to design surface and track progress
- Easily measure distances, slopes and heights to compare with site measurements

SUBCONTRACTOR MANAGEMENT

- Perform quick volume calculations of material moved for progress payments
- See proof of site changes via a visual timeline
- Fewer disputes as your portal can be shared with subcontractors so everyone is on the same page

ROAD AND TRAFFIC MANAGEMENT

- Measure road grades, cross-slopes, road widths and windrow heights with one click. Optimize traffic plans with a complete, up-to-date site map, and easily direct personnel to where they need to be
- Reduce cycle times and optimize mobile plant efficiency by tracking haul road design conformance

SAFETY

- Reduce people-to-machine interactions by surveying inaccessible or hazardous areas safely using a drone
- Get overall site images for inspection works, without sending personnel on-site
- Track changes in slope angles to better manage slips

ENVIRONMENTAL RESPONSIBILITIES

- Get frequent, detailed images of site boundaries and protected areas to easily demonstrate your conformance with regulatory requirement

PROJECT EFFICIENCY

- Integrates with Trimble Business Center and Trimble Site Positioning Systems for consistent local coordinate definition
- Conduct your own site surveys for more accurate estimates
- Tighter plans and budgets as a result of more frequent and accurate volume data
- Fewer site visits needed when people can track progress and inspect work remotely
- No more information silos or unnecessary hold-ups when everyone can work from the same current survey data

TRIMBLE SITEWORKS SYSTEMS

FOR CONSTRUCTION SURVEYORS AND SUPERVISORS

The fully integrated Trimble Siteworks Positioning Systems are designed to eliminate downtime by making every minute more productive. With increased processing power and Microsoft® Windows® 10, the systems enable quicker handling of complex files and 3D data sets, all on a much larger screen—meaning you can spot issues and solve problems before they slow you down.

SITWORKS POSITIONING SYSTEMS

For Surveyors

The Trimble Siteworks Positioning System for Construction Surveyors is comprised of the SPS986 or SPS785 GNSS Smart Antenna, the TSC7 Controller or T7 Tablet and Siteworks Software.

Key Features

- Work with complex 3D models
- Collect large data sets faster
- Visualize and manipulate complex 3D models more easily
- Work day or night efficiently

Components

- Trimble Siteworks Software
- Trimble TSC7 Controller or T7 Tablet
- Trimble SPS986 GNSS Smart Antenna
- Trimble SPS785 GNSS Smart Antenna

For Supervisors

The Trimble Siteworks Positioning System for Supervisors includes the SPS986 or SPS785 GNSS Smart Antenna, T7 or T10 Tablet and Siteworks Software.

Key Features

- Run full office software packages, including Trimble Business Center and Microsoft Office
- Work easily with data and 3D models in the field
- Leave the laptop in the office

Components

- Trimble Siteworks Software
- Trimble T7 or T10 Tablet
- Trimble SPS986 GNSS Smart Antenna
- Trimble SPS785 GNSS Smart Antenna



MADE FOR THE WAY YOU WORK

CONNECTED CONTROLLERS

Find the controller that best fits your needs and budget. Along with the options below, Siteworks Software also supports the Android operating system, increasing the flexibility and affordability of the Siteworks System.

Trimble TSC7 Controller

A bigger screen, powerful processing power and Microsoft® Windows® 10 means you're carrying all the potential of a laptop, right in the palm of your hand.

- 7-inch sunlight readable display
- Back lit keyboard
- Hot-swappable long-life lithium-ion batteries

Trimble Tablets

The Trimble T7 Tablet is a 7-inch lightweight, rugged handheld controller for GNSS or total station operations. The rugged Trimble T10 Tablet gives you high performance processing power in the field, on a 10.1-inch screen.

- Sunlight readable display
- Microsoft® Windows® 10
- Military grade ruggedness
- Hot-swappable long-life lithium-ion batteries

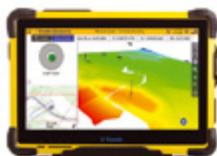

SMART(ER) RECEIVERS

The Trimble SPS986 GNSS Smart Antenna is engineered to stand up to the most dynamic and rugged jobsite measurement applications.

- Ultra-rugged
- Integrated IMU for eBubble and tilt compensation
- Supports all GNSS constellations or rover



The Trimble SPS785 GNSS Smart Antenna can be used as a base or rover, featuring Trimble quality and accuracy priced for a faster return on investment.

- GNSS receiver, antenna and battery in one unit
- Inside-the-rod UHF antenna for maximum protection and reliability
- Long range Bluetooth®



TILT COMPENSATION

Using the Trimble SPS986 GNSS Smart Antenna, construction surveyors can capture accurate points without leveling the pole. Full GNSS tilt compensation makes Siteworks easier to learn for beginners and saves significant time for more experienced surveyors.

- Easily and safely survey hard to reach areas (corners, traffic lanes, utility lowlines)
- Faster measurements
- More efficient stake-outs
- Minimal magnetic interference

Capture accurate points while standing, walking or driving the site in a vehicle. Tilt compensation in vehicle mode is designed to capture higher accuracy measurements on steeper slopes from a moving vehicle, and more accurate volume measurements to save time and money on material planning.

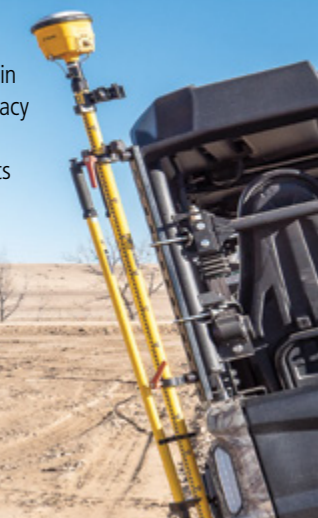

TRIMBLE SITE POSITIONING SYSTEMS

FOR CONSTRUCTION SURVEYING OR MACHINE CONTROL APPLICATIONS

THE RIGHT TOOLS TO DO THE JOB RIGHT

Trimble Site Positioning Systems give contractors targeted tools for every person on the jobsite; work at every stage is performed faster, with fewer errors and less material costs.

Trimble Site Positioning Systems provide:

- The ability to measure, stake, check, manage, inspect
- Control and communications infrastructure
- Tools to move data between the office, machines, and site personnel
- The confidence to finish projects on time, on cost, and on specification

From the field, truck, or office, any person on the construction site can be connected and equipped with accurate positioning, consistent digital design information and the ability to locate, measure and record information. Contractors can share information, track results instantly, make smarter decisions, and manage multiple jobsites with ease. Data can be leveraged across more professionals on the jobsite, making every resource a direct contributor to the success of the project.



Trimble SPS855 GNSS Modular Receiver

Whether you need a reliable GNSS base station or a rugged rover, the Trimble SPS855 GNSS Modular Receiver gives you the flexibility to perform all of your construction site measurements. As a permanent or semi-permanent base station, it provides GNSS corrections for site measurements and machine control. As a rover, it can move easily from a site supervisor truck to a pole mount for grade checking, site measurement and stakeout.



Trimble Site Mobile

Combining a camera, a controller and a smartphone into one lightweight device, the Site Mobile is so easy-to-use, inexperienced employees can begin using the system for simple positioning tasks in less than an hour. Now anyone on the construction site can be equipped with accurate positioning and digital designs, saving you time, money and rework.



Trimble Total Stations

Trimble offers a full range of high accuracy total stations. The robotic Universal Total Stations come equipped with the industry's fastest servos, ensuring accurate high speed tracking of the target, making them ideal for machine control and site positioning. They include 3Hz scanning capabilities for the rapid scanning of surfaces such as deep cuts, rock faces and stockpiles in dangerous or inaccessible locations. Trimble also offers entry level total stations that are a cost-effective alternative for site measurement and stakeout. With an operating range of 1640 feet (500 meters), they are ideal for smaller site operations and work on structures such as bridges or culverts.



Trimble TSC3 Controller

The Trimble TSC3 Controller is water and dust resistant to withstand the toughest weather and jobsite conditions. The display is designed for operation in all light conditions whether at night or in the bright sunshine. And it operates in temperatures ranging from -22 °F to +140 °F (-30 °C to +60 °C).



THE CONNECTED QUARRY



POTENTIAL IMPROVEMENT
20%
 more productivity using Trimble technology

Optimize assets by tracking productivity

Knowledge is power. LOADRITE and InsightHQ enables the Connected Quarry which helps you manage your operation from wherever you are. It gives you the power to manage your operations, tracking the main drivers of your business. Easy-to-use reporting helps track daily operations and major process change management. Simple graphs help quickly identify bottlenecks and workflow issues.

InsightHQ is a productivity and performance reporting and management portal showing near real time productivity, from your LOADRITE scales. With insightHQ you can:

- See site performance and productivity information presented in an easy to read graphs and tables
- Respond to issues, optimize production and productivity with accurate data
- Control your data, how, when and where you want it, all during the shift
- Access anywhere, anytime on your web browser or mobile device

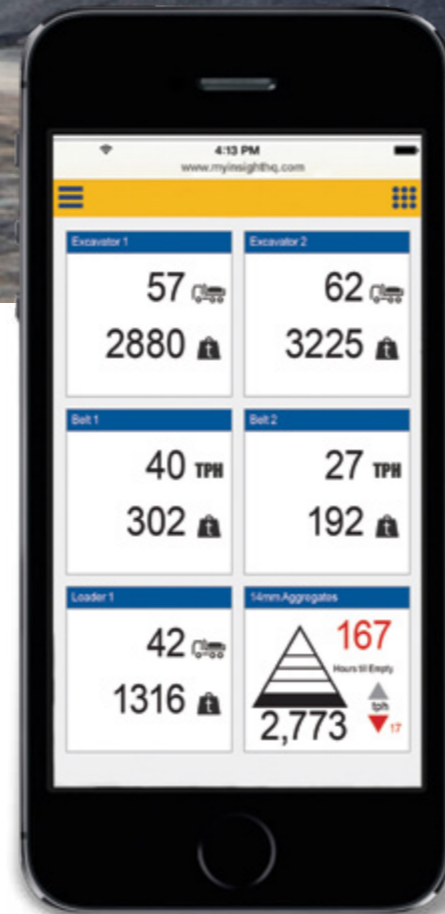

WHAT IS REALLY HAPPENING IN YOUR OPERATION?

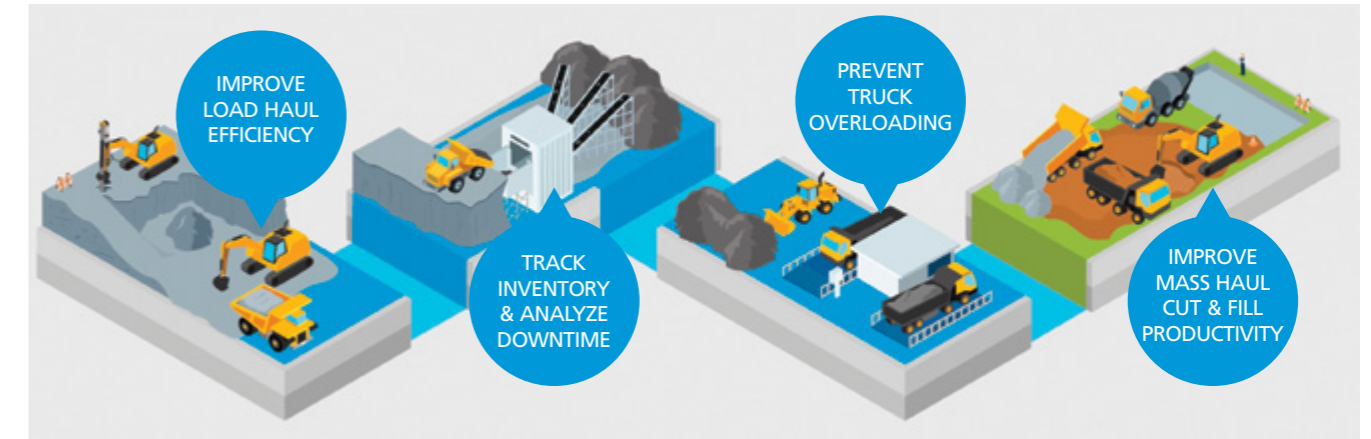

SITECH provides the tools and support for the extraction, processing, loadout, transportation and construction phases of aggregates industries for more efficient operations and higher profits.



LOADOUT MANAGEMENT SYSTEM AND LOADER SCALES (LR360)

LOADRITE 360 for Loadout is a Connected Quarry solution that improves loadout operations through accurate onboard weighing, metric tracking, job data automation, and real-time 360° job visibility. LOADRITE 360 connects the loader and scale house to provide data sharing of loadout jobs which result in greater efficiency, improved visibility and higher product sales.

- Accurate onboard weighing (+/- 1% margin of error)
- POS system and in-cab automated connection
- Real-time job list
- True tare trucking loading



HAUL TRUCK MONITOR (H2250)

The LOADRITE H2250 provides near real-time reporting of haul truck productivity and process monitoring, to help increase production and reduce costs.

- Detailed cycle time reports
- Productivity reporting
- Overloading, tray up, tip over, carry back and speeding operator warnings

PAYLOAD MANAGEMENT SYSTEMS



LOAD ONCE, LOAD RIGHT

Trimble LOADRITE Payload management systems support the Connected Quarry and the Connected Site by accurately measuring material production and movement. All LOADRITE systems are compatible with InsightHQ and LOADRITE printers.

For more information visit loadritescales.com



LOADER SMARTSCALE (L3180)

A SmartScale is the next generation of loader onboard scale that uses smarter weighing intelligence for more accurate, precise and faster loading. It also connects machines and devices for the collection and syncing of loading data. Also features:

- Smarter weighing (~40% more precise)
- Connected Quarry connectivity including built-in WiFi and GPS
- Best-in-class interactivity and interface
- New paperless eTicket workflow

Trimble LOADRITE onboard scales ensure optimal loading and quality data for productivity analysis. LOADRITE systems are installed on wheel loaders, excavators, conveyor belts and other equipment across a range of industries—construction, aggregate, mining, waste management, and more.

The accuracy you can expect from a LOADRITE weighing system is demonstrated by 'Legal for Trade' approval in many countries around the world.

EXCAVATOR SCALES (X2350)

LOADRITE excavator scales can improve the load haul operation in the pit or measure real-time progress of the mass-haul cut-fill operation at the construction site.

- Accurate to $\pm 3\%$ margin of error
- Dynamic 2D and 3D weighing
- Option for mining-class machines (X2650)



LOADER SCALES (L2180, L2150, FORCE)

LOADRITE L2180 is the world's #1 selling loader scale. It, the L2150 and Force onboard scales provides accurate bucket payload to measure and optimize loadout for production and utility loaders.

- Accurate to $\pm 1\%$ margin of error
- Connect to printer, and InsightHQ web portal via a browser or mobile device
- 'Legal for Trade' option available



TRACTOR, COMPACT MACHINE SCALES (S1100)

The Trimble S1100 on board scale that provides an accurate in-cab payload measurement for compact machines. It is suitable for use on tractors, forklifts and skidsteers, across a range of machine sizes, brands and models.

- Reliable accuracy to within $\pm 2\%$ margin of error
- Easy-to-use and compact interface
- Support for up to 9 attachments



REACH STACKER SCALES (L2180)

Ensure compliance to SOLAS regulations, track and improve container handling with accurate weight information. The L2180 weighing system verify the weights of every container moved, so you can provide accurate information for logistics compliance and reporting.

- Superior non-disruptive weighing
- 'Legal for Trade' option available
- Multiple data field capture and reporting

CONVEYOR BELT SCALES (C2880, C2850)

LOADRITE belt scales measure and report TPH, stockpile totals and black belt time. The ideal tool for monitoring inventory, production output and product load out, while providing essential data management tools to drive productivity and machine performance decisions.

- Accurate measurement of production and performance (including downtime/black-belt-time)
- Suitable for fixed plant (C2880) and mobile crushers, screeners and stackers (C2850).



MARINE CONSTRUCTION

SITECH offers a wide range of site positioning and marine construction positioning systems, GNSS receivers and antennas developed by Trimble, the leader in GNSS technology for marine solutions.

For more information visit, trimble.com/marine

TRIMBLE MARINE CONSTRUCTION (TMC) SYSTEMS

Improve productivity and efficiency in underwater marine construction applications including dredging, crane operations, piling and hydrographic survey. TMC provides accurate 3D visualization to assist the operator with underwater construction tasks.

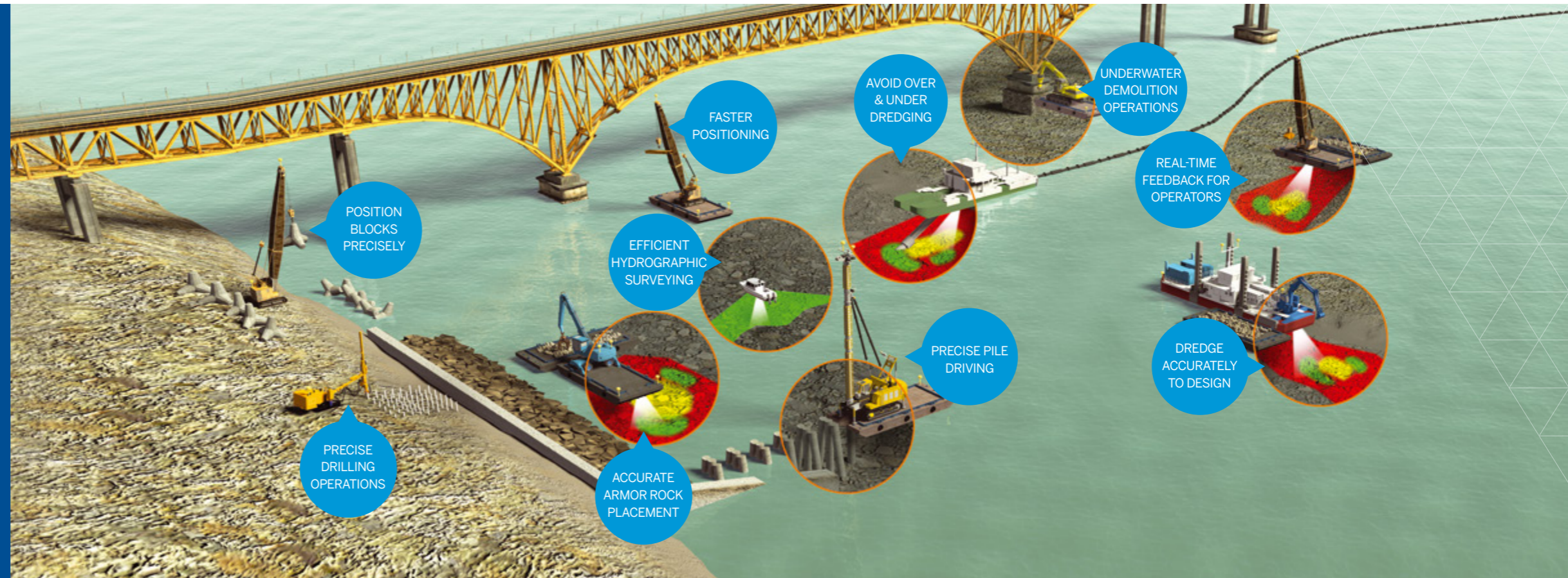
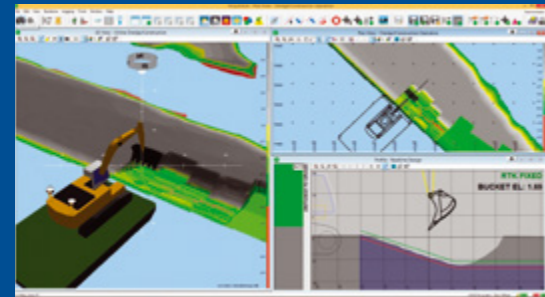

OUR MARINE SYSTEM APPLICATIONS INCLUDE:

- Dredge positioning and guidance (Backhoe Excavator, Bucket Dredger, Cutter Suction Dredger, Grab/Clamshell Dredger)
- Placement (Coastal Defence Rock Dumping and Placement, Caisson Placement, Block Placement using Wire crane or Excavator, Vertical and Raked pile placement)
- Hydrographic survey (Single beam or Multibeam) environmental data collection for applications such as channel maintenance, dredging progress, environmental surveys, and bed erosion
- Positioning and tracking of barges, tugs and other construction vessels
- Offshore-rig-positioning and anchor-handling applications

TRIMBLE MPS865 MARINE GNSS

The Trimble® MPS865 is a highly versatile, rugged and reliable Global Navigation Satellite System (GNSS) marine positioning solution. Features maximum connectivity - Bluetooth, WiFi, UHF radio, cellular modem and two MSS satellite correction channels.



GNSS MODULAR RECEIVERS

Save time, money and headaches with the SPS855 base station solution, includes remote monitoring and alerts, an internal radio and rover capability.

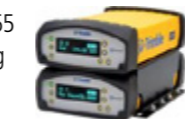

The BX992 GNSS Heading Receiver is a dual-antenna GNSS receiver offering precise heading capability and multi-frequency support for all known constellations.



GNSS ANTENNAS

Trimble offers several models of GNSS antennas to suit your specific application, signal tracking and budget requirements including the SPS785 and SPS986.



GNSS CORRECTION SOURCES

Your GNSS operations are only as good as your correction source. It's important, so we let you choose the right one for you. Larger sites may need a local GNSS base station for the highest precision, smaller sites may opt for a virtual correction source.



MARINE INERTIAL POSITIONING SYSTEM

The Trimble Marine Inertial Positioning System is a compact dual antenna system that provides robust and precise 3D position and orientation data in the most challenging of marine environments.



GNSS RADIOS

Trimble radios offer flexible configuration options and rugged reliability for efficient use of GNSS on the construction site.



HYDROPRO SOFTWARE

HYDROpro software for entry level hydrographic survey and marine construction projects such as rig and barge positioning, and piling.

You buy Trimble construction hardware and software because you know you can count on Trimble solutions to get the job done. Your Trimble equipment comes with a factory warranty that is our promise to you that we stand behind our Trimble products. Because we understand that you may want to continue to use your Trimble hardware and software beyond the warranty period, Trimble offers additional coverage with Trimble Protected Plus protection plans. Trimble Protected Plus protection plans make good business sense and are an excellent way to protect your cash flow and minimize the risk of doing business.



NO-WORRY HARDWARE COVERAGE

A Trimble Protected Plus protection plan covers everything that is covered in your original Trimble hardware factory warranty. If the unexpected happens and your equipment has to be repaired, that's no problem! Your protection plan ensures that you pay nothing out of pocket for parts and labor on covered repairs. There's also no deductible or fee associated with covered repairs. Repairs are typically completed faster because there's no need for your distributor to generate an estimate and get your approval before starting work. Protection plans are money and time savers.

Value Add features

Our protection plans provide additional features and benefits to you as long as you own the coverage. Our protection plans value-add features include:

- An annual inspect-clean and calibration service for total stations
- Protection against wear and tear from repetitive use that causes your equipment to not function to specification, for example:
 - If the part can no longer perform the function to which it was designed solely because of its condition (due to usage), it's covered by wear and tear
 - Cosmetic damage that does not affect the functioning of the unit is excluded from wear and tear coverage
- Equipment damage protection from surges in Trimble power supplies
- Protection from environmental damage from dust, heat, humidity and salt air when used in accordance with intended equipment specifications

HARDWARE BENEFITS

- Trimble Protected Plus protection plans are the only service plans designed specifically for buyers of new Trimble Civil Engineering and Construction hardware and software; they enhance and sustain your entire ownership experience with worry free coverage
- An annual protection plan costs less than the average repair cost
- Our Trimble Protected coverage entitles you to a new piece of equipment with comparable features if yours can't be fixed, or if it simply makes more sense to replace it
- It's backed by Trimble Inc.
- You can prorate your plans to update all your equipment on an annual expiration date - no need to remember multiple payment dates to ensure your coverage does not lapse
- Locks in tomorrow's repair costs at today's prices
- A protection plan keeps you running, minimizing unnecessary downtime and improving your overall efficiency

WHY COVER YOUR SOFTWARE WITH A PROTECTION PLAN?

Adding a Trimble Protected Plus protection plan for your SCS900 and Siteworks software safeguards your software and your investment beyond the factory warranty, ensuring you can keep your projects generating revenue.

After expiration of the original software factory warranty, our protection plans cover:

- Compatibility to added hardware
- Access to ongoing software updates and enhancements
- Fixes to known issues
- Ability to relinquish and transfer the software license

This means more predictable performance, productivity, and an increase in your software lifecycle.

SOFTWARE BENEFITS

- A protection plan keeps your data workflow set running at the highest performance level possible
- You can streamline your software management by prorating all your plans into one single payment
- A protection plan gives you the ability to relinquish and transfer a license to another device
- Your software plan becomes more valuable to your business when you add a Trimble Protected Plus protection plan; it is the only way to get the ongoing software updates from Trimble other than purchasing new software
- A protection plan prevents incompatibility issues between the software and the hardware in the field and will in most cases save you time and money



THE TRIMBLE PROTECTED PROMISE

Trimble wants to keep you a satisfied protection plan customer for life so we guarantee to stand behind you and your hardware and/or software plans for as long as you own your coverage.

Complete Trimble Protected Plus protection plan terms and conditions can be found online at:

Trimble.com/TrimbleProtected/Protection_Plans_Overview

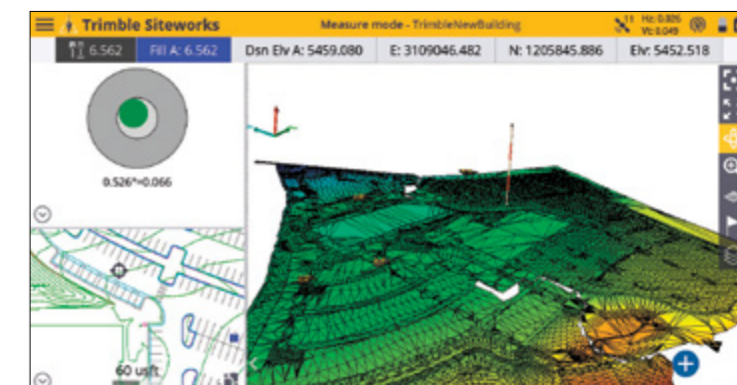

SITECH SERVICES

YOUR LOCAL PARTNER



SERVICE CENTER

As a Trimble® Authorized Service Provider, we offer a wide range of technical services, all conducted by highly qualified technicians utilizing professional tools and highly precise equipment. Unforeseen repair and service costs and downtime can be significantly reduced through periodic calibration and preventative maintenance, and you benefit from equipment that is always in top condition. The broad service offering includes certification services, repairs and product upgrades.

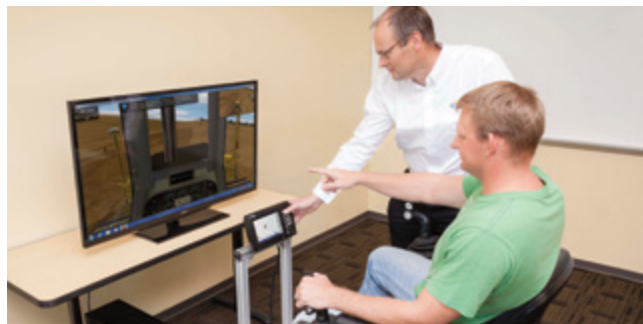

TRAINING

Trimble construction technology is a game changer – and to benefit from all its power, you want to make sure to take advantage of SITECH's expert professional training.



Whether you and your crew are new to machine automation, you need a refresher or there are team members who have recently joined, let's talk and make sure you get the right training.

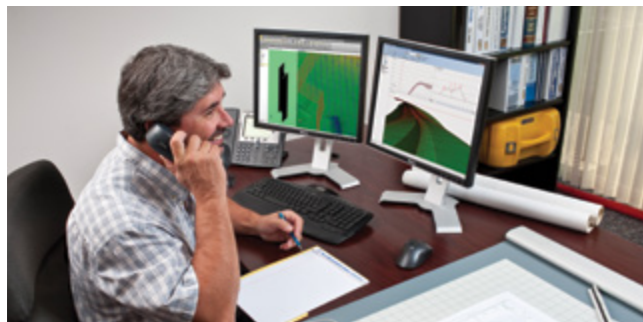

SITECH SUPPORT

Our Support Team is dedicated to making sure your downtime is kept to a minimum. We have office based staff, just a phone call away 24/7. Many issues can be resolved over the phone or with Trimble Remote Connect.



RENTAL

Get what you need, when you need it. Take advantage of our various rental programs to dip your toes – you'll get the job done right and you'll experience the benefits of the newest state of the art technology, while you take your time to make the final decision.



During your rental period, if you realize that you don't want to give up the value you have just discovered, there's an answer for you, our convenient rental conversion.

People and technology you can rely on.

SITECH® is the leading distributor of easy-to-use, proven Trimble technology for construction companies of all sizes. From Trimble machine control systems to site positioning systems and construction office software - with SITECH you will find the right support, knowledge and experience to increase your productivity and profitability through the use of powerful and connected technology.



Close to you.



©2018-2019, Trimble Inc. All rights reserved. Trimble, the Globe & Triangle logo, and SITECH are trademarks of Trimble Inc., registered in the United States and in other countries. All other trademarks are the property of their respective owners. PN 022482-3943A (05/19)

